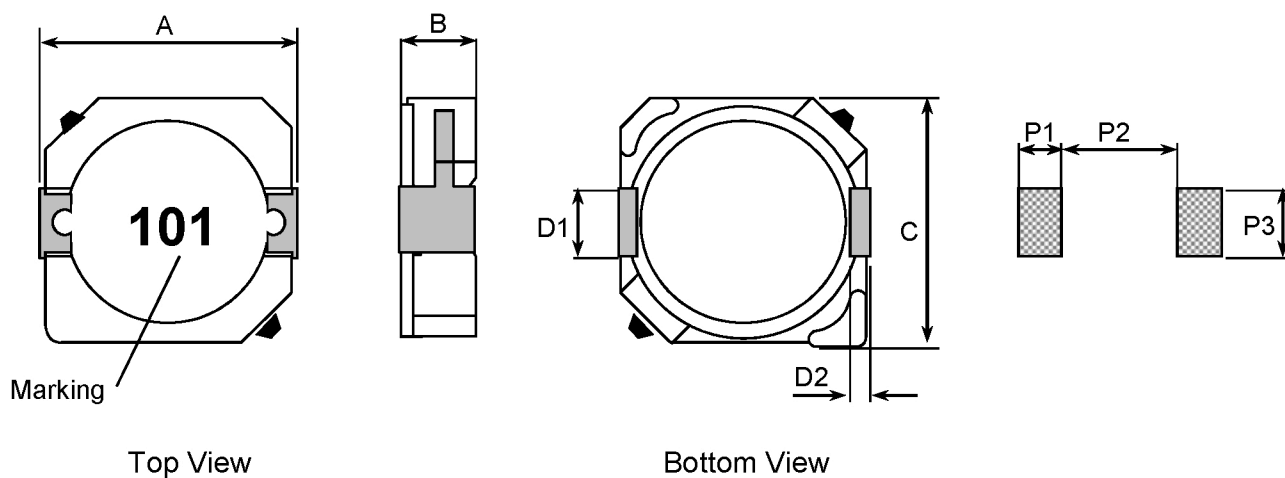

SPECIFICATION**Compliant RoHS**

DIMENSION: mm

A	B	C	D1	D2	P1	P2	P3
11 max	5.5 max	11 max	3±0.2	1.2±0.2	2 Ref	7 Ref	3.5 Ref

**ELECTRONIC CHARACTERISTICS**

INDUCTANCE TH2832LCR f=100KHz/0.1V	DCR at 25°C TH2516B	DCI TH2816B+TH1773	Rated Current (A)max
100μH±20%	0.28 Ω max	L 1.3A≥L0A×70%	1.3A