



Film Capacitors

Metallized Polypropylene Film Capacitors (MFP)

Series/Type: B32632 ... B32634

Date: May 2009

Very high pulse (wound)

Typical applications

- Smoothing
- High-frequency AC loads
- Switch-mode power supplies
- Electronic ballasts
- HID lamps

Climatic

- Max. operating temperature: 110 °C
- Climatic category (IEC 60068-1): 55/100/56

Construction

- Dielectric: polypropylene (PP)
- Film metallized on one side and metal foils internally connected in series
- Contact layer of sprayed metal
- Wound capacitor technology
- Epoxy resin coating (UL 94 V-0)

Features

- Highest possible contact reliability
- Very high pulse strength
- Self-healing properties

Terminals

- Crimped wire leads, lead-free tinned, lead length (6 – 1 mm)
- Double crimped wire leads, lead-free tinned
- Straight wire leads, lead-free tinned, lead length (17 ±3 mm)
- Different lead spacings (reduced and enlarged) available, lead length (6 – 1 mm)

Marking

Manufacturer's logo, style and type (P63x),
rated capacitance (coded),
capacitance tolerance (code letter),
rated DC voltage, date of manufacture (coded)

Delivery mode

Bulk (untaped)
Taped (Ammo pack or reel)
For notes on taping, refer to chapter "Taping and packing".



Dimensional drawings

Crimped leads

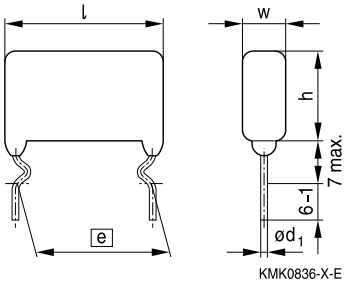

Double crimped leads

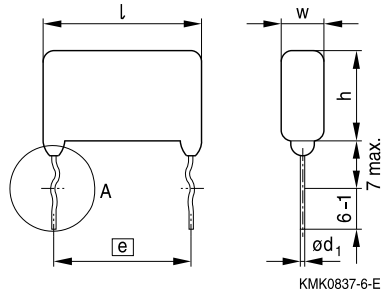

Straight leads

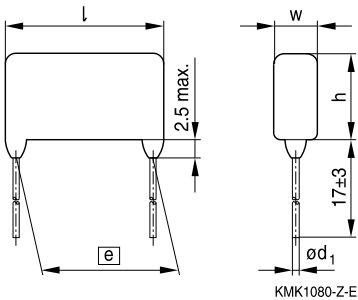

Detail of double crimped version

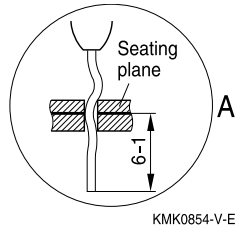

Dimensions in mm

Lead spacing	Lead diameter	Type
$e \pm 0.8$	d_1	
15.0	0.8	B32632
22.5	0.8	B32633
27.5	0.8	B32634

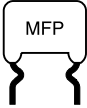





B32632 ... B32634

Very high pulse (wound)

Overview of available types

Lead spacing	15.0 mm					22.5 mm					
Type	B32632					B32633					
V _R (V DC)	630	1250	1600	2000	3000	630	1250	1600	2000	2500	3000
V _{RMS} (V AC)	300	450	450	500	750	300	450	450	500	750	750
C _R (nF)											
0.47											
0.68											
1.0											
1.5											
2.2											
3.3											
4.7											
6.8											
10											
15											
22											
33											
47											
68											
100											





Lead configurations

Series	Standard	Reduced	Straight	Double crimped
				
B32632	15 mm	7.5 / 10 / 12.5 mm	15 mm	15 mm
B32633	22.5 mm	15 / 17.5 / 20 mm	22.5 mm	22.5 mm
B32634	27.5 mm	25 mm	27.5 mm	27.5 mm

Overview of available types

Lead spacing	27.5 mm			
Type	B32634			
V_R (V DC)	630	1250	1600	2000
V_{RMS} (V AC)	300	450	450	500
C_R (nF)				
10				
15				
22				
33				
47				
68				
100				
150				
220				
330				

Lead configurations

Series	Standard	Reduced	Straight	Double crimped
				
B32632	15 mm	7.5 / 10 / 12.5 mm	15 mm	15 mm
B32633	22.5 mm	15 / 17.5 / 20 mm	22.5 mm	22.5 mm
B32634	27.5 mm	25 mm	27.5 mm	27.5 mm

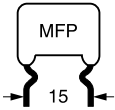
B32632
Very high pulse (wound)
Ordering codes and packing units (lead spacing 15 mm)

V_R	V_{RMS} $f \leq 1$ kHz	C_R	Max. dimensions $w \times h \times l$ mm	Ordering code (composition see below)	Ammo pack pcs./MOQ	Reel pcs./MOQ	Untaped pcs./MOQ
V DC	V AC	nF					
630	300	2.2	6.0 × 11.5 × 18.5	B32632B6222+***	3600	4800	4000
		3.3	6.0 × 11.5 × 18.5	B32632B6332+***	3600	4800	4000
		4.7	6.0 × 11.5 × 18.5	B32632B6472+***	3600	4800	4000
		6.8	6.0 × 11.5 × 18.5	B32632B6682+***	3600	4800	4000
		10	6.0 × 11.5 × 18.5	B32632B6103+***	3600	4800	4000
		15	6.5 × 12.0 × 18.5	B32632B6153+***	3200	4000	4000
		22	7.5 × 13.5 × 18.5	B32632B6223+***	2800	3600	4000
		33	9.0 × 15.0 × 18.5	B32632B6333+***	2400	3200	2000
		47	11.0 × 16.5 × 18.5	B32632B6473+***	1800	2400	2000
1250	450	1.0	6.0 × 11.5 × 18.5	B32632B7102+***	3400	4400	4000
		1.5	6.0 × 11.5 × 18.5	B32632B7152+***	3400	4400	4000
		2.2	6.5 × 12.0 × 18.5	B32632B7222+***	3400	4400	4000
		3.3	6.5 × 12.0 × 18.5	B32632B7332+***	3200	4000	4000
		4.7	7.0 × 12.5 × 18.5	B32632B7472+***	3200	4000	4000
		6.8	7.5 × 14.0 × 18.5	B32632B7682+***	3000	4000	4000
		10	9.0 × 15.0 × 18.5	B32632B7103+***	2400	3200	2000
		15	11.5 × 16.5 × 18.5	B32632B7153+***	1800	2400	2000

MOQ = Minimum Order Quantity, consisting of 4 packing units.

B32632B2471M*** and B32632B2681M*** are only available in M tolerance.

B32632B4471K*** and B32632B4681K*** are only available in K tolerance.

Further E series and intermediate capacitance values on request.

Composition of ordering code

+ = Capacitance tolerance code:

M = ±20%

K = ±10%

J = ±5%

*** = Packaging code:

289 = Ammo pack

189 = Reel

010 = Untaped crimped (lead length 6 – 1 mm)

008 = Untaped straight (lead length 17±3 mm)

020 = Double crimped (lead length 6 – 1 mm)

Packaging codes for further lead configurations (untaped):

Lead configuration (lead length 6 – 1 mm)	Reduced	Reduced	Reduced	Enlarged
Lead spacing (mm)	7.5 mm	10 mm	12.5 mm	17.5 mm
Packaging code	030	040	050	060

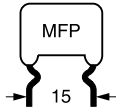
Ordering codes and packing units (lead spacing 15 mm)

V_R	V_{RMS} $f \leq 1$ kHz	C_R	Max. dimensions $w \times h \times l$ mm	Ordering code (composition see below)	Ammo pack pcs./MOQ	Reel pcs./MOQ	Untaped pcs./MOQ
V DC	V AC	nF					
1600	450	1.0	$6.0 \times 11.5 \times 18.5$	B32632B1102+***	3600	4800	4000
		1.5	$6.0 \times 11.5 \times 18.5$	B32632B1152+***	3600	4800	4000
		2.2	$6.5 \times 12.0 \times 18.5$	B32632B1222+***	3200	4000	4000
		3.3	$7.5 \times 13.0 \times 18.5$	B32632B1332+***	2800	3600	4000
		4.7	$8.5 \times 14.0 \times 18.5$	B32632B1472+***	2400	3200	4000
		6.8	$9.5 \times 15.0 \times 18.5$	B32632B1682+***	2000	2800	2000
		10	$11.5 \times 17.0 \times 18.5$	B32632B1103+***	1800	2400	2000
2000	500	0.47	$6.5 \times 11.5 \times 18.5$	B32632B2471M***	3400	4400	4000
		0.68	$6.5 \times 12.0 \times 18.5$	B32632B2681M***	3400	4400	4000
		1.0	$6.5 \times 12.0 \times 18.5$	B32632B2102+***	3400	4400	4000
		1.5	$6.5 \times 12.0 \times 18.5$	B32632B2152+***	3400	4400	4000
		2.2	$7.0 \times 13.0 \times 18.5$	B32632B2222+***	2400	4000	2000
		3.3	$8.5 \times 14.5 \times 18.5$	B32632B2332+***	2600	3400	2000
		4.7	$10.0 \times 16.0 \times 18.5$	B32632B2472+***	2000	2800	2000
6.8	$12.0 \times 17.5 \times 18.5$	B32632B2682+***	1800	2400	2000		
3000	750	0.47	$6.5 \times 11.5 \times 18.5$	B32632B4471K***	4000	5200	4000
		0.68	$7.0 \times 13.0 \times 18.5$	B32632B4681K***	3600	4800	4000
		1.0	$8.5 \times 14.0 \times 18.5$	B32632B4102+***	3000	4000	2000
		1.5	$9.5 \times 16.5 \times 18.5$	B32632B4152+***	2600	3400	2000
		2.2	$12.0 \times 17.5 \times 18.5$	B32632B4222+***	2000	2800	2000

MOQ = Minimum Order Quantity, consisting of 4 packing units.

B32632B2471M*** and B32632B2681M*** are only available in M tolerance.

B32632B4471K*** and B32632B4681K*** are only available in K tolerance.

Further E series and intermediate capacitance values on request.

Composition of ordering code

+ = Capacitance tolerance code:

M = $\pm 20\%$

K = $\pm 10\%$

J = $\pm 5\%$

*** = Packaging code:

289 = Ammo pack

189 = Reel

010 = Untaped crimped (lead length 6 – 1 mm)

008 = Untaped straight (lead length 17 \pm 3 mm)

020 = Double crimped (lead length 6 – 1 mm)

Packaging codes for further lead configurations (untaped):

Lead configuration (lead length 6 – 1 mm)	Reduced	Reduced	Reduced	Enlarged
Lead spacing (mm)	7.5 mm	10 mm	12.5 mm	17.5 mm
Packaging code	030	040	050	060

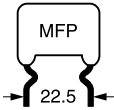
B32633
Very high pulse (wound)
Ordering codes and packing units (lead spacing 22.5 mm)

V_R	V_{RMS} $f \leq 1$ kHz	C_R	Max. dimensions $w \times h \times l$ mm	Ordering code (composition see below)	Ammo pack pcs./MOQ	Reel pcs./MOQ	Untaped pcs./MOQ
V DC	V AC	nF					
630	300	22	$6.5 \times 12.0 \times 27.0$	B32633B6223+***	2200	3000	4000
		33	$7.0 \times 14.0 \times 27.0$	B32633B6333+***	2000	2800	2000
		47	$7.5 \times 14.5 \times 27.0$	B32633B6473+***	1800	2400	2000
		68	$9.0 \times 16.0 \times 27.0$	B32633B6683+***	1400	2000	2000
		100	$10.5 \times 18.5 \times 27.0$	B32633B6104+***	1200	1600	1000
1250	450	10	$7.0 \times 14.0 \times 27.0$	B32633B7103+***	2000	2800	2000
		15	$8.0 \times 15.5 \times 27.0$	B32633B7153+***	1800	2400	2000
		22	$9.5 \times 16.5 \times 27.0$	B32633B7223+***	1400	2000	2000
		33	$11.5 \times 19.0 \times 27.0$	B32633B7333+***	1200	1600	1000
		47	$13.5 \times 20.5 \times 27.0$	B32633B7473+***	1000	1400	1000
1600	450	3.3	$6.5 \times 12.5 \times 27.0$	B32633B1332+***	2000	2800	4000
		4.7	$6.5 \times 12.5 \times 27.0$	B32633B1472+***	2000	2800	4000
		6.8	$7.0 \times 14.5 \times 27.0$	B32633B1682+***	2000	2400	2000
		10	$8.0 \times 15.5 \times 27.0$	B32633B1103+***	1800	2600	2000
		15	$9.5 \times 17.0 \times 27.0$	B32633B1153+***	1400	2000	1000
		22	$11.5 \times 19.0 \times 27.0$	B32633B1223+***	1200	1600	1000
		33	$14.5 \times 22.0 \times 27.0$	B32633B1333+***	1000	1200	1000
2000	500	2.2	$6.5 \times 13.0 \times 27.0$	B32633B2222+***	2000	2800	4000
		3.3	$6.5 \times 13.0 \times 27.0$	B32633B2332+***	2000	2800	4000
		4.7	$7.0 \times 14.5 \times 27.0$	B32633B2472+***	2000	2800	2000
		6.8	$8.5 \times 16.0 \times 27.0$	B32633B2682+***	1600	2200	2000
		10	$10.0 \times 17.0 \times 27.0$	B32633B2103+***	1400	1800	1000
		15	$12.0 \times 19.5 \times 27.0$	B32633B2153+***	1000	1400	1000
		22	$14.5 \times 22.0 \times 27.0$	B32633B2223+***	800	1200	1000

MOQ = Minimum Order Quantity, consisting of 4 packing units.

Further E series and intermediate capacitance values on request.

Composition of ordering code

+ = Capacitance tolerance code:

K = $\pm 10\%$

J = $\pm 5\%$

*** = Packaging code:

289 = Ammo pack

189 = Reel

010 = Untaped crimped (lead length 6 – 1 mm)

008 = Untaped straight (lead length 17 ± 3 mm)

020 = Double crimped (lead length 6 – 1 mm)

Packaging codes for further lead configurations (untaped):

Lead configuration (lead length 6 – 1 mm)	Reduced	Reduced	Reduced	Enlarged
Lead spacing (mm)	15 mm	17.5 mm	20 mm	25 mm
Packaging code	055	060	070	080

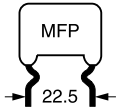
Ordering codes and packing units (lead spacing 22.5 mm)

V_R	V_{RMS} $f \leq 1$ kHz	C_R	Max. dimensions $w \times h \times l$ mm	Ordering code (composition see below)	Ammo pack pcs./MOQ	Reel pcs./MOQ	Untaped pcs./MOQ
V DC	V AC	nF					
2500	750	1.0	7.0 × 13.5 × 27.0	B32633B3102+***	1800	2600	4000
		1.5	7.0 × 14.0 × 27.0	B32633B3152+***	1800	2600	4000
		2.2	7.5 × 15.0 × 27.0	B32633B3222+***	1800	2400	2000
		3.3	9.0 × 16.0 × 27.0	B32633B3332+***	1400	2000	2000
		4.7	10.0 × 18.0 × 27.0	B32633B3472+***	1400	2000	2000
		6.8	12.0 × 20.5 × 27.0	B32633B3682+***	1200	1600	1000
		10	14.0 × 23.0 × 27.0	B32633B3103+***	1000	1400	1000
		15	17.0 × 26.0 × 27.0	B32633B3153+***	800	1200	800
3000	750	1.0	6.5 × 12.0 × 27.0	B32633B4102+***	2600	3600	2000
		1.5	7.5 × 13.5 × 27.0	B32633B4152+***	2200	3000	2000
		2.2	8.5 × 15.0 × 27.0	B32633B4222+***	1800	2600	2000
		3.3	10.0 × 17.0 × 27.0	B32633B4332+***	1600	2200	2000
		4.7	11.5 × 19.0 × 27.0	B32633B4472+***	1200	1800	2000
		6.8	13.0 × 22.0 × 27.0	B32633B4682+***	1000	1400	800

MOQ = Minimum Order Quantity, consisting of 4 packing units.

Further E series and intermediate capacitance values on request.

Composition of ordering code

+ = Capacitance tolerance code:

K = ±10%

J = ±5%

*** = Packaging code:

289 = Ammo pack

189 = Reel

010 = Untaped crimped (lead length 6 – 1 mm)

008 = Untaped straight (lead length 17±3 mm)

020 = Double crimped (lead length 6 – 1 mm)

Packaging codes for further lead configurations (untaped):

Lead configuration (lead length 6 – 1 mm)	Reduced	Reduced	Reduced	Enlarged
Lead spacing (mm)	15 mm	17.5 mm	20 mm	25 mm
Packaging code	055	060	070	080

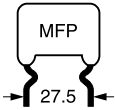
B32634
Very high pulse (wound)
Ordering codes and packing units (lead spacing 27.5 mm)

V_R	V_{RMS} $f \leq 1 \text{ kHz}$	C_R	Max. dimensions $w \times h \times l$	Ordering code (composition see below)	Untaped pcs./MOQ
V DC	V AC	nF	mm		
630	300	100	9.5 × 18.0 × 32.0	B32634B6104+***	1000
		150	11.5 × 20.5 × 32.0	B32634B6154+***	800
		220	13.5 × 22.5 × 32.0	B32634B6224+***	800
		330	16.0 × 25.5 × 32.0	B32634B6334+***	600
1250	450	33	9.5 × 18.0 × 32.0	B32634B7333+***	1000
		47	11.5 × 20.0 × 32.0	B32634B7473+***	1000
		68	13.0 × 23.0 × 32.0	B32634B7683+***	800
		100	16.0 × 26.0 × 32.0	B32634B7104+***	600
1600	450	15	8.5 × 17.0 × 32.0	B32634B1153+***	2000
		22	10.0 × 18.5 × 32.0	B32634B1223+***	1000
		33	12.0 × 21.5 × 32.0	B32634B1333+***	1000
		47	14.0 × 22.5 × 32.0	B32634B1473+***	800
		68	16.0 × 25.5 × 32.0	B32634B1683+***	600
2000	500	10	8.5 × 17.0 × 32.0	B32634A2103+***	2000
		15	10.0 × 19.5 × 32.0	B32634A2153+***	1000
		22	12.0 × 21.5 × 32.0	B32634A2223+***	1000
		33	15.0 × 24.0 × 32.0	B32634A2333+***	800

MOQ = Minimum Order Quantity, consisting of 4 packing units.

Further E series and intermediate capacitance values on request.

Composition of ordering code

+ = Capacitance tolerance code:

K = ±10%

J = ±5%

*** = Packaging code:

010 = Untaped crimped (lead length 6 – 1 mm)

008 = Untaped straight (lead length 17±3 mm)

020 = Double crimped (lead length 6 – 1 mm)

Packing codes for further lead configurations (untaped):

Lead configuration (lead length 6 – 1 mm)	Reduced
Lead spacing (mm)	25 mm
Packing code	090

Technical data

Operating temperature range	Max. operating temperature $T_{op,max}$	+110 °C	
	Upper category temperature T_{max}	+100 °C	
	Lower category temperature T_{min}	-55 °C	
	Rated temperature T_R	+85 °C	
Dissipation factor $\tan \delta$ at 20 °C (upper limit values)	1.0 · 10 ⁻³ (at 10 kHz)		
	2.0 · 10 ⁻³ (at 100 kHz)		
Insulation resistance R_{ins} at 20 °C, rel. humidity ≤ 65% (minimum as-delivered values)	100 GΩ		
DC test voltage	2.0 · V_R , 2 s (B32632/3000 V DC: 1.2 · V_R , 2 s; B32633/3000 V DC: 1.6 · V_R , 2 s)		
Category voltage V_C (continuous operation with V_{DC} or V_{AC} at $f \leq 1$ kHz)	T_A (°C)	DC voltage derating	AC voltage derating
	$T_A \leq 85$ $85 < T_A \leq 100$	$V_C = V_R$ $V_C = V_R \cdot (165 - T_A)/80$	$V_{C,RMS} = V_{RMS}$ $V_{C,RMS} = V_{RMS} \cdot (165 - T_A)/80$
Operating voltage V_{op} for short operating periods (V_{DC} or V_{AC} at $f \leq 1$ kHz)	T_A (°C)	DC voltage (max. hours)	AC voltage (max. hours)
	$T_A \leq 85$ $85 < T_A \leq 100$	$V_{op} = 1.25 \cdot V_C$ (2000 h) $V_{op} = 1.25 \cdot V_C$ (1000 h)	$V_{op} = 1.0 \cdot V_{C,RMS}$ (2000 h) $V_{op} = 1.0 \cdot V_{C,RMS}$ (1000 h)
Damp heat test Limit values after damp heat test	56 days/40 °C/93% relative humidity Capacitance change $ \Delta C/C $ ≤ 2% Dissipation factor change $\Delta \tan \delta$ ≤ 1.0 · 10 ⁻³ (at 10 kHz) Insulation resistance R_{ins} ≥ 50% of minimum as-delivered values		
Reliability: Failure rate λ Service life t_{SL}	1 fit (≤ 2 · 10 ⁻⁹ /h) at 0.5 · V_R , 40 °C 200 000 h at 1.0 · V_R , 85 °C For conversion to other operating conditions and temperatures, refer to chapter "Quality, 2 Reliability".		
Failure criteria: Total failure Failure due to variation of parameters	Short circuit or open circuit Capacitance change $ \Delta C/C $ > 10% Dissipation factor $\tan \delta$ > 4 · upper limit value Insulation resistance R_{ins} < 1500 MΩ		

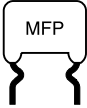

B32632 ... B32634

Very high pulse (wound)

Pulse handling capability

"dV/dt" represents the maximum permissible voltage change per unit of time for non-sinusoidal voltages, expressed in V/ μ s.

"k₀" represents the maximum permissible pulse characteristic of the waveform applied to the capacitor, expressed in V²/ μ s.

Note:

The values of dV/dt and k₀ provided below must not be exceeded in order to avoid damaging the capacitor.

dV/dt values

Lead spacing		15 mm	22.5 mm	27.5 mm
V _R V DC	V _{RMS} V AC	dV/dt in V/ μ s		
630	300	6 000	3 600	2 400
1250	450	14 400	8 400	5 400
1600	450	16 800	10 800	6 600
2000	500	20 400	14 400	8 400
2500	750	–	16 800	–
3000	750	21 600	18 000	–

k₀ values

Lead spacing		15 mm	22.5 mm	27.5 mm
V _R V DC	V _{RMS} V AC	k ₀ in V ² / μ s		
630	300	7 560 000	4 536 000	3 024 000
1250	450	36 000 000	21 000 000	13 500 000
1600	450	53 760 000	34 560 000	21 120 000
2000	500	81 600 000	57 600 000	33 600 000
2500	750	–	84 000 000	–
3000	750	129 600 000	108 000 000	–

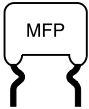

Impedance Z versus frequency f

(typical values)

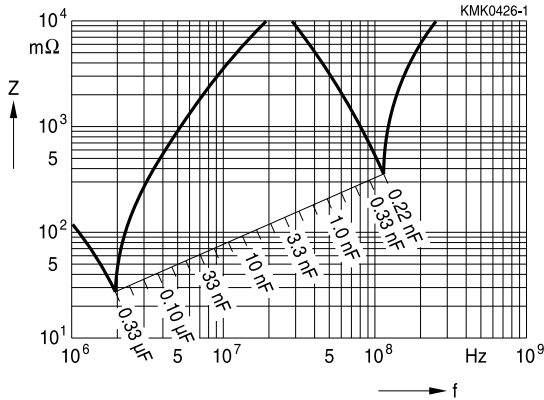

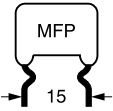

B32632

Very high pulse (wound)

Permissible AC voltage V_{RMS} versus frequency f (for sinusoidal waveforms, $T_A \leq 90^\circ C$)
 For $T_A > 90^\circ C$, please refer to "General technical information", section 3.2.3.

Lead spacing 15 mm

630 V DC/300 V AC

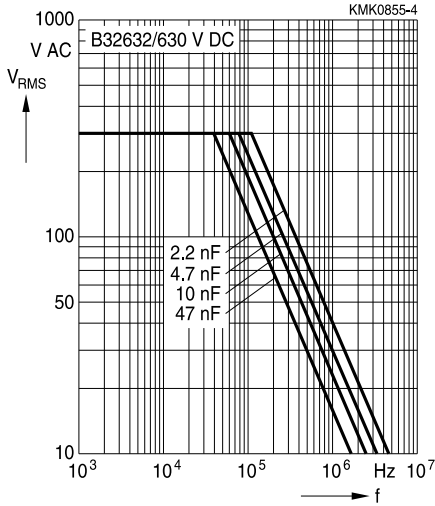

1250 V DC/450 V AC

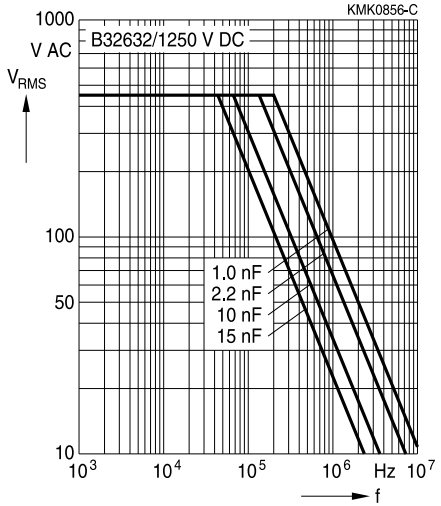

1600 V DC/450 V AC

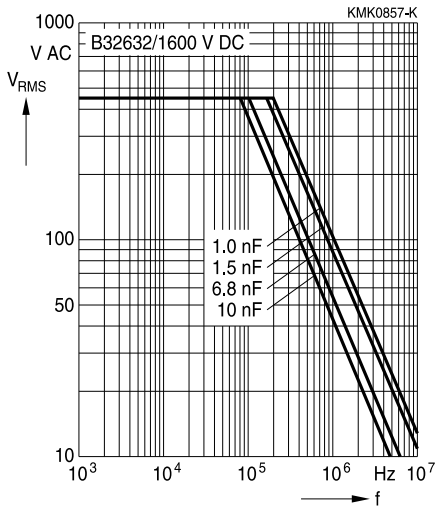

2000 V DC/500 V AC

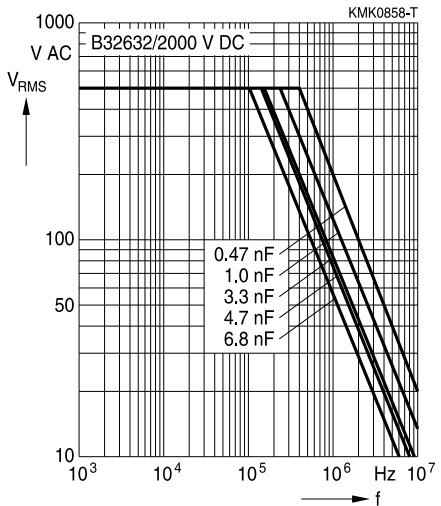

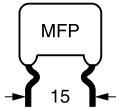

Permissible AC voltage V_{RMS} versus frequency f (for sinusoidal waveforms, $T_A \leq 90\text{ °C}$)
 For $T_A > 90\text{ °C}$, please refer to "General technical information", section 3.2.3.

Lead spacing 15 mm

3000 V DC/750 V AC

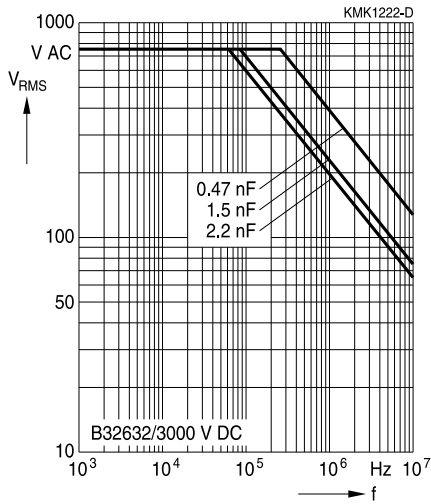

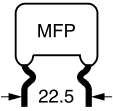

B32633

Very high pulse (wound)

Permissible AC voltage V_{RMS} versus frequency f (for sinusoidal waveforms, $T_A \leq 90^\circ C$)
 For $T_A > 90^\circ C$, please refer to "General technical information", section 3.2.3.

Lead spacing 22.5 mm

630 V DC/300 V AC

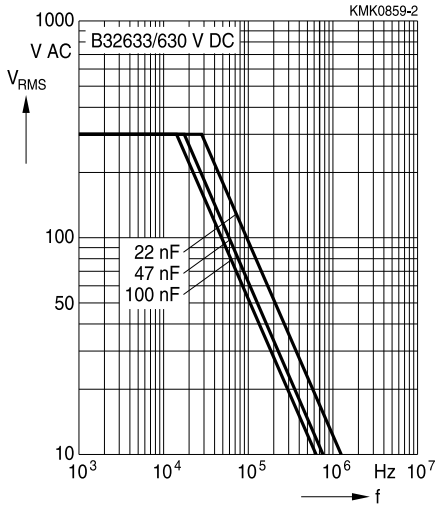

1250 V DC/450 V AC

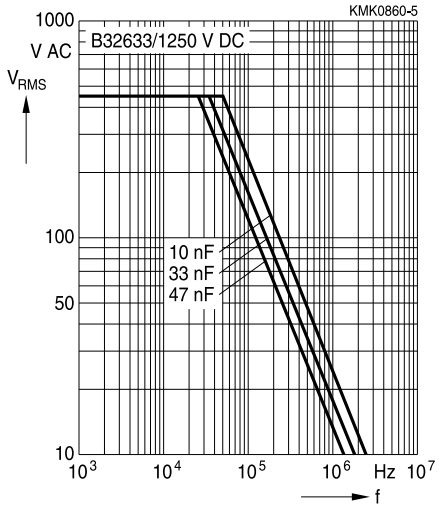

1600 V DC/450 V AC

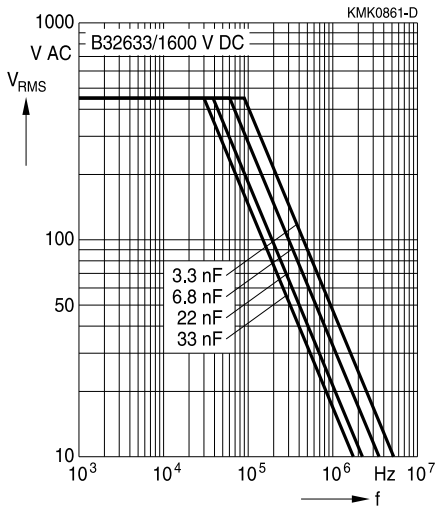

2000 V DC/500 V AC

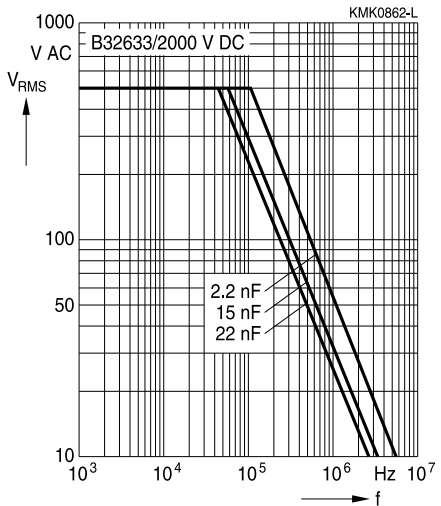

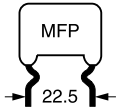

Permissible AC voltage V_{RMS} versus frequency f (for sinusoidal waveforms, $T_A \leq 90^\circ C$)
 For $T_A > 90^\circ C$, please refer to "General technical information", section 3.2.3.

Lead spacing 22.5 mm

2500 V DC/750 V AC

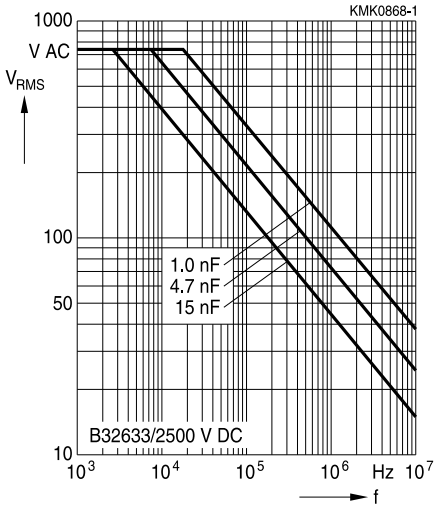

3000 V DC/750 V AC

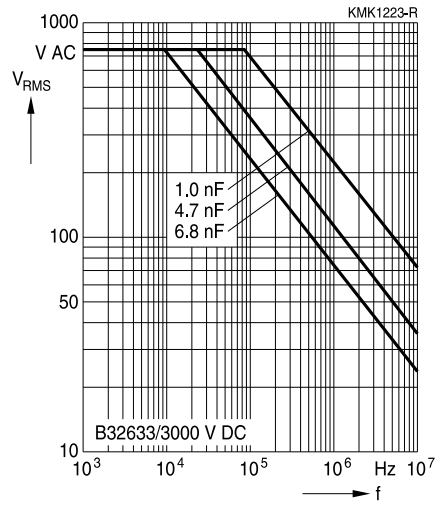

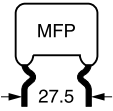

B32634

Very high pulse (wound)

Permissible AC voltage V_{RMS} versus frequency f (for sinusoidal waveforms, $T_A \leq 90^\circ C$)
 For $T_A > 90^\circ C$, please refer to "General technical information", section 3.2.3.

Lead spacing 27.5 mm

630 V DC/300 V AC

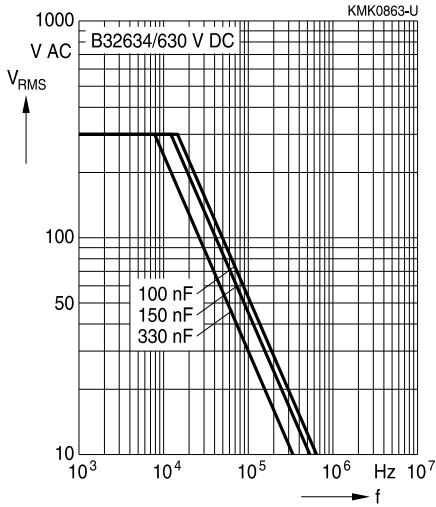

1250 V DC/450 V AC

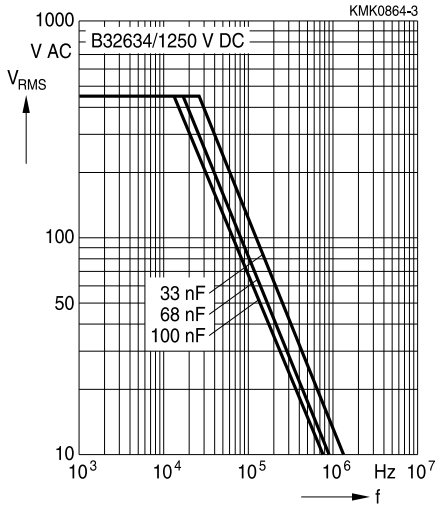

1600 V DC/450 V AC

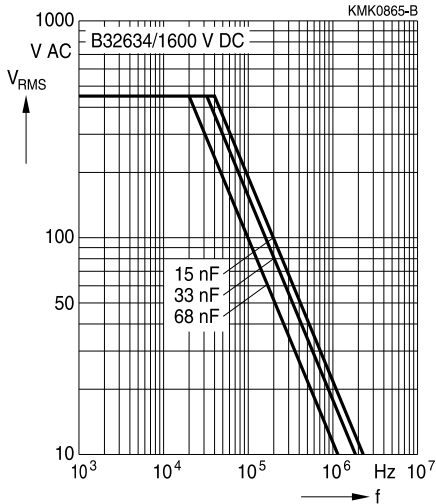

2000 V DC/500 V AC

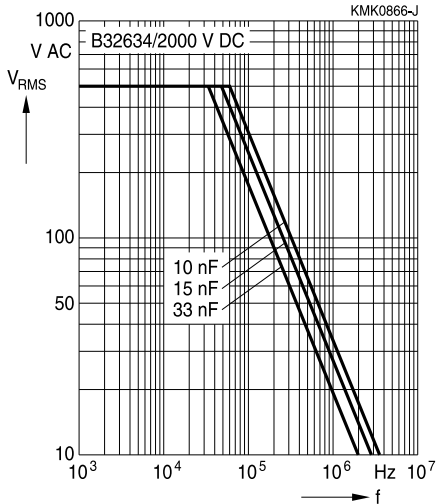

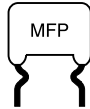

Mounting guidelines

1 Soldering

1.1 Solderability of leads

The solderability of terminal leads is tested to IEC 60068-2-20, test Ta, method 1.

Before a solderability test is carried out, terminals are subjected to accelerated ageing (to IEC 60068-2-2, test Ba: 4 h exposure to dry heat at 155 °C). Since the ageing temperature is far higher than the upper category temperature of the capacitors, the terminal wires should be cut off from the capacitor before the ageing procedure to prevent the solderability being impaired by the products of any capacitor decomposition that might occur.

Solder bath temperature	235 ±5 °C
Soldering time	2.0 ±0.5 s
Immersion depth	2.0 +0/-0.5 mm from capacitor body or seating plane
Evaluation criteria: Visual inspection	Wetting of wire surface by new solder ≥90%, free-flowing solder

1.2 Resistance to soldering heat

Resistance to soldering heat is tested to IEC 60068-2-20, test Tb, method 1A.

Conditions:

Series	Solder bath temperature	Soldering time
MKT boxed (except 2.5 × 6.5 × 7.2 mm) coated uncoated (lead spacing > 10 mm)	260 ±5 °C	10 ±1 s
MFP MKP (lead spacing > 7.5 mm)		
MKT boxed (case 2.5 × 6.5 × 7.2 mm)		5 ±1 s
MKP (lead spacing ≤ 7.5 mm) MKT uncoated (lead spacing ≤ 10 mm) insulated (B32559)		< 4 s recommended soldering profile for MKT uncoated (lead spacing ≤ 10 mm) and insulated (B32559)



B32632 ... B32634

Very high pulse (wound)

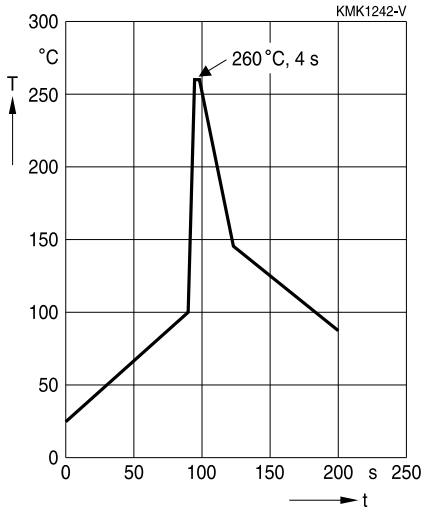

Immersion depth	2.0 +0/−0.5 mm from capacitor body or seating plane
Shield	Heat-absorbing board, (1.5 ±0.5) mm thick, between capacitor body and liquid solder
Evaluation criteria:	
Visual inspection	No visible damage
$\Delta C/C_0$	2% for MKT/MKP/MFP 5% for EMI suppression capacitors
$\tan \delta$	As specified in sectional specification



1.3 General notes on soldering

Permissible heat exposure loads on film capacitors are primarily characterized by the upper category temperature T_{max} . Long exposure to temperatures above this type-related temperature limit can lead to changes in the plastic dielectric and thus change irreversibly a capacitor's electrical characteristics. For short exposures (as in practical soldering processes) the heat load (and thus the possible effects on a capacitor) will also depend on other factors like:

- Pre-heating temperature and time
- Forced cooling immediately after soldering
- Terminal characteristics:
 - diameter, length, thermal resistance, special configurations (e.g. crimping)
- Height of capacitor above solder bath
- Shadowing by neighboring components
- Additional heating due to heat dissipation by neighboring components
- Use of solder-resist coatings

The overheating associated with some of these factors can usually be reduced by suitable countermeasures. For example, if a pre-heating step cannot be avoided, an additional or reinforced cooling process may possibly have to be included.

EPCOS recommends the following conditions:

- Pre-heating with a maximum temperature of 110 °C
- Temperature inside the capacitor should not exceed the following limits:
 - MKP/MFP 110 °C
 - MKT 160 °C
- When SMD components are used together with leaded ones, the leaded film capacitors should not pass into the SMD adhesive curing oven. The leaded components should be assembled after the SMD curing step.
- Leaded film capacitors are not suitable for reflow soldering.

Uncoated capacitors

For uncoated MKT capacitors with lead spacings ≤ 10 mm (B32560/B32561) the following measures are recommended:

- pre-heating to not more than 110 °C in the preheater phase
- rapid cooling after soldering



B32632 ... B32634

Very high pulse (wound)

2 Cleaning

To determine whether the following solvents, often used to remove flux residues and other substances, are suitable for the capacitors described, refer to the table below:

Type	Ethanol, isopropanol, n-propanol	n-propanol-water mixtures, water with surface tension-reducing tensides (neutral)	Solvent from table A (see next page)	Solvent from table B (see next page)
MKT (uncoated)	Suitable	Unsuitable	In part suitable	Unsuitable
MKT, MKP, MFP (coated/boxed)		Suitable	Suitable	

Even when suitable solvents are used, a reversible change of the electrical characteristics may occur in uncoated capacitors immediately after they are washed. Thus it is always recommended to dry the components (e.g. 4 h at 70 °C) before they are subjected to subsequent electrical testing.

Table A

Manufacturers' designations for trifluoro-trichloro-ethane-based cleaning solvents (selection)

Trifluoro-trichloro-ethane	Mixtures of trifluoro-trichloro-ethane with ethanol and isopropanol	Manufacturer
Freon TF	Freon TE 35; Freon TP 35; Freon TES	Du Pont
Frigen 113 TR	Frigen 113 TR-E; Frigen 113 TR-P; Frigen TR-E 35	Hoechst
Arklone P	Arklone A; Arklone L; Arklone K	ICI
Kaltron 113 MDR	Kaltron 113 MDA; Kaltron 113 MDI; Kaltron 113 MDI 35	Kali-Chemie
Flugene 113	Flugene 113 E; Flugene 113 IPA	Rhone-Progil

Table B (worldwide banned substances)

Manufacturers' designations for unsuitable cleaning solvents (selection)

Mixtures of chlorinated hydrocarbons and ketones with fluorated hydrocarbons	Manufacturer
Freon TMC; Freon TA; Freon TC	Du Pont
Arklone E	ICI
Kaltron 113 MDD; Kaltron 113 MDK	Kali-Chemie
Flugene 113 CM	Rhone-Progil

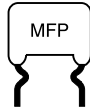

3 Embedding of capacitors in finished assemblies

In many applications, finished circuit assemblies are embedded in plastic resins. In this case, both chemical and thermal influences of the embedding ("potting") and curing processes must be taken into account.

Our experience has shown that the following potting materials can be recommended: non-flexible epoxy resins with acid-anhydride hardeners; chemically inert, non-conducting fillers; maximum curing temperature of 100 °C.

Caution:

Consult us first if you wish to embed uncoated types!

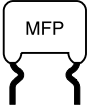

B32632 ... B32634
Very high pulse (wound)

Cautions and warnings

- Do not exceed the upper category temperature (UCT).
- Do not apply any mechanical stress to the capacitor terminals.
- Avoid any compressive, tensile or flexural stress.
- Do not move the capacitor after it has been soldered to the PC board.
- Do not pick up the PC board by the soldered capacitor.
- Do not place the capacitor on a PC board whose PTH hole spacing differs from the specified lead spacing.
- Do not exceed the specified time or temperature limits during soldering.
- Avoid external energy inputs, such as fire or electricity.
- Avoid overload of the capacitors.

The table below summarizes the safety instructions that must always be observed. A detailed description can be found in the relevant sections of the chapters "General technical information" and "Mounting guidelines".

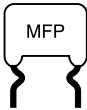
Topic	Safety information	Reference chapter "General technical information"
Storage conditions	Make sure that capacitors are stored within the specified range of time, temperature and humidity conditions.	4.5 "Storage conditions"
Flammability	Avoid external energy, such as fire or electricity (passive flammability), avoid overload of the capacitors (active flammability) and consider the flammability of materials.	5.3 "Flammability"
Resistance to vibration	Do not exceed the tested ability to withstand vibration. The capacitors are tested to IEC 60068-2-6. EPCOS offers film capacitors specially designed for operation under more severe vibration regimes such as those found in automotive applications. Consult our catalog "Film Capacitors for Automotive Electronics".	5.2 "Resistance to vibration"



Very high pulse (wound)

Topic	Safety information	Reference chapter "Mounting guidelines"
Soldering	Do not exceed the specified time or temperature limits during soldering.	1 "Soldering"
Cleaning	Use only suitable solvents for cleaning capacitors.	2 "Cleaning"
Embedding of capacitors in finished assemblies	When embedding finished circuit assemblies in plastic resins, chemical and thermal influences must be taken into account. Caution: Consult us first, if you also wish to embed other uncoated component types!	3 "Embedding of capacitors in finished assemblies"

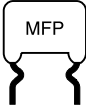
Symbols and terms

Symbol	English	German
α	Heat transfer coefficient	Wärmeübergangszahl
α_C	Temperature coefficient of capacitance	Temperaturkoeffizient der Kapazität
A	Capacitor surface area	Kondensatoroberfläche
β_C	Humidity coefficient of capacitance	Feuchtekoeffizient der Kapazität
C	Capacitance	Kapazität
C_R	Rated capacitance	Nennkapazität
ΔC	Absolute capacitance change	Absolute Kapazitätsänderung
$\Delta C/C$	Relative capacitance change (relative deviation of actual value)	Relative Kapazitätsänderung (relative Abweichung vom Ist-Wert)
$\Delta C/C_R$	Capacitance tolerance (relative deviation from rated capacitance)	Kapazitätstoleranz (relative Abweichung vom Nennwert)
dt	Time differential	Differentielle Zeit
Δt	Time interval	Zeitintervall
ΔT	Absolute temperature change (self-heating)	Absolute Temperaturänderung (Selbsterwärmung)
$\Delta \tan \delta$	Absolute change of dissipation factor	Absolute Änderung des Verlustfaktors
ΔV	Absolute voltage change	Absolute Spannungsänderung
dV/dt	Time differential of voltage function (rate of voltage rise)	Differentielle Spannungsänderung (Spannungsflankensteilheit)
$\Delta V/\Delta t$	Voltage change per time interval	Spannungsänderung pro Zeitintervall
E	Activation energy for diffusion	Aktivierungsenergie zur Diffusion
ESL	Self-inductance	Eigeninduktivität
ESR	Equivalent series resistance	Ersatz-Serienwiderstand
f	Frequency	Frequenz
f_1	Frequency limit for reducing permissible AC voltage due to thermal limits	Grenzfrequenz für thermisch bedingte Reduzierung der zulässigen Wechselspannung
f_2	Frequency limit for reducing permissible AC voltage due to current limit	Grenzfrequenz für strombedingte Reduzierung der zulässigen Wechselspannung
f_r	Resonant frequency	Resonanzfrequenz
F_D	Thermal acceleration factor for diffusion	Therm. Beschleunigungsfaktor zur Diffusion
F_T	Derating factor	Deratingfaktor
i	Current (peak)	Stromspitze
I_C	Category current (max. continuous current)	Kategoriestrom (max. Dauerstrom)

Symbol	English	German
I_{RMS}	(Sinusoidal) alternating current, root-mean-square value	(Sinusförmiger) Wechselstrom
i_z	Capacitance drift	Inkonstanz der Kapazität
k_0	Pulse characteristic	Impuls Kennwert
L_S	Series inductance	Serieninduktivität
λ	Failure rate	Ausfallrate
λ_0	Constant failure rate during useful service life	Konstante Ausfallrate in der Nutzungsphase
λ_{test}	Failure rate, determined by tests	Experimentell ermittelte Ausfallrate
P_{diss}	Dissipated power	Abgegebene Verlustleistung
P_{gen}	Generated power	Erzeugte Verlustleistung
Q	Heat energy	Wärmeenergie
ρ	Density of water vapor in air	Dichte von Wasserdampf in Luft
R	Universal molar constant for gases	Allg. Molarkonstante für Gas
R	Ohmic resistance of discharge circuit	Ohmscher Widerstand des Entladekreises
R_i	Internal resistance	Innenwiderstand
R_{ins}	Insulation resistance	Isolationswiderstand
R_P	Parallel resistance	Parallelwiderstand
R_S	Series resistance	Serienwiderstand
S	severity (humidity test)	Schärfegrad (Feuchtestest)
t	Time	Zeit
T	Temperature	Temperatur
τ	Time constant	Zeitkonstante
$\tan \delta$	Dissipation factor	Verlustfaktor
$\tan \delta_D$	Dielectric component of dissipation factor	Dielektrischer Anteil des Verlustfaktors
$\tan \delta_P$	Parallel component of dissipation factor	Parallelanteil des Verlustfaktors
$\tan \delta_S$	Series component of dissipation factor	Serienanteil des Verlustfaktors
T_A	Ambient temperature	Umgebungstemperatur
T_{max}	Upper category temperature	Obere Kategorietemperatur
T_{min}	Lower category temperature	Untere Kategorietemperatur
t_{OL}	Operating life at operating temperature and voltage	Betriebszeit bei Betriebstemperatur und -spannung
T_{op}	Operating temperature	Betriebstemperatur
T_R	Rated temperature	Nenntemperatur
T_{ref}	Reference temperature	Referenztemperatur
t_{SL}	Reference service life	Referenz-Lebensdauer
V_{AC}	AC voltage	Wechselspannung

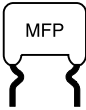
B32632 ... B32634
Very high pulse (wound)

Symbol	English	German
V_C	Category voltage	Kategoriespannung
$V_{C,RMS}$	Category AC voltage	(Sinusförmige) Kategorie-Wechselspannung
V_{CD}	Corona-discharge onset voltage	Teilentlade-Einsatzspannung
V_{ch}	Charging voltage	Ladespannung
V_{DC}	DC voltage	Gleichspannung
V_{FB}	Fly-back capacitor voltage	Spannung (Flyback)
V_i	Input voltage	Eingangsspannung
V_o	Output voltage	Ausgangssspannung
V_{op}	Operating voltage	Betriebsspannung
V_p	Peak pulse voltage	Impuls-Spitzenspannung
V_{pp}	Peak-to-peak voltage Impedance	Spannungshub
V_R	Rated voltage	Nennspannung
\hat{V}_R	Amplitude of rated AC voltage	Amplitude der Nenn-Wechselspannung
V_{RMS}	(Sinusoidal) alternating voltage, root-mean-square value	(Sinusförmige) Wechselspannung
V_{SC}	S-correction voltage	Spannung bei Anwendung "S-correction"
V_{sn}	Snubber capacitor voltage	Spannung bei Anwendung "Beschaltung"
Z	Impedance	Scheinwiderstand
e	Lead spacing	Rastermaß

Important notes

The following applies to all products named in this publication:

1. Some parts of this publication contain **statements about the suitability of our products for certain areas of application**. These statements are based on our knowledge of typical requirements that are often placed on our products in the areas of application concerned. We nevertheless expressly point out **that such statements cannot be regarded as binding statements about the suitability of our products for a particular customer application**. As a rule, EPCOS is either unfamiliar with individual customer applications or less familiar with them than the customers themselves. For these reasons, it is always ultimately incumbent on the customer to check and decide whether an EPCOS product with the properties described in the product specification is suitable for use in a particular customer application.
2. We also point out that **in individual cases, a malfunction of electronic components or failure before the end of their usual service life cannot be completely ruled out in the current state of the art, even if they are operated as specified**. In customer applications requiring a very high level of operational safety and especially in customer applications in which the malfunction or failure of an electronic component could endanger human life or health (e.g. in accident prevention or lifesaving systems), it must therefore be ensured by means of suitable design of the customer application or other action taken by the customer (e.g. installation of protective circuitry or redundancy) that no injury or damage is sustained by third parties in the event of malfunction or failure of an electronic component.
3. **The warnings, cautions and product-specific notes must be observed.**
4. In order to satisfy certain technical requirements, **some of the products described in this publication may contain substances subject to restrictions in certain jurisdictions (e.g. because they are classed as hazardous)**. Useful information on this will be found in our Material Data Sheets on the Internet (www.epcos.com/material). Should you have any more detailed questions, please contact our sales offices.
5. We constantly strive to improve our products. Consequently, **the products described in this publication may change from time to time**. The same is true of the corresponding product specifications. Please check therefore to what extent product descriptions and specifications contained in this publication are still applicable before or when you place an order. We also **reserve the right to discontinue production and delivery of products**. Consequently, we cannot guarantee that all products named in this publication will always be available. The aforementioned does not apply in the case of individual agreements deviating from the foregoing for customer-specific products.
6. Unless otherwise agreed in individual contracts, **all orders are subject to the current version of the "General Terms of Delivery for Products and Services in the Electrical Industry" published by the German Electrical and Electronics Industry Association (ZVEI)**.
7. The trade names EPCOS, BAOKE, Alu-X, CeraDiode, CSMP, CSSP, CTVS, DSSP, MiniBlue, MKK, MLSC, MotorCap, PCC, PhaseCap, PhaseCube, PhaseMod, SIFERRIT, SIFI, SIKOREL, SilverCap, SIMDAD, SIMID, SineFormer, SIOV, SIP5D, SIP5K, ThermoFuse, WindCap are **trademarks registered or pending** in Europe and in other countries. Further information will be found on the Internet at www.epcos.com/trademarks.